



With “Aru NORDIC 90 Ex” windows a giant leap has been made in the development of outward opening windows. The product combines masterly design and energy efficiency  $U_w=0,78 \text{ W/m}^2\text{K}$ .

High-end 52 mm glazing units are used instead of 26 mm ones, which allows glass to become a unity with deep timber profiles, resulting in an outstanding temperature and sound isolation but retaining product’s slim line from the visual perspective.



A multi-layered deep-impregnated window, the bottom sash is protected with an aluminium glazing bead. To reduce heat loss at the edge of the glass, we recommend using an insulated glazing that has SWS (plastic) spacers rather than the traditional metal.

# Aru NORDIC 90 EX

## OUTWARD OPENING VACUUM DEEP-IMPREGNATED WOODEN WINDOW

Standard window thermal transmittance  $U_w=0,78 \text{ W/m}^2\text{K}$

### CROSS SECTIONS

Frame: 115x50 mm

Sash: 90 x 62mm

### GLASS

Triple glazing, 52mm ( $U \geq 0,47 \text{ W/m}^2\text{K}$ )

Glazing from the outside with wooden glazing bead

Fastened with hidden nails, sealed with silicone

Bottom glazing bead - aluminium

SEALS around the sash and frame

TIMBER FINISHING with water-based paint or stain

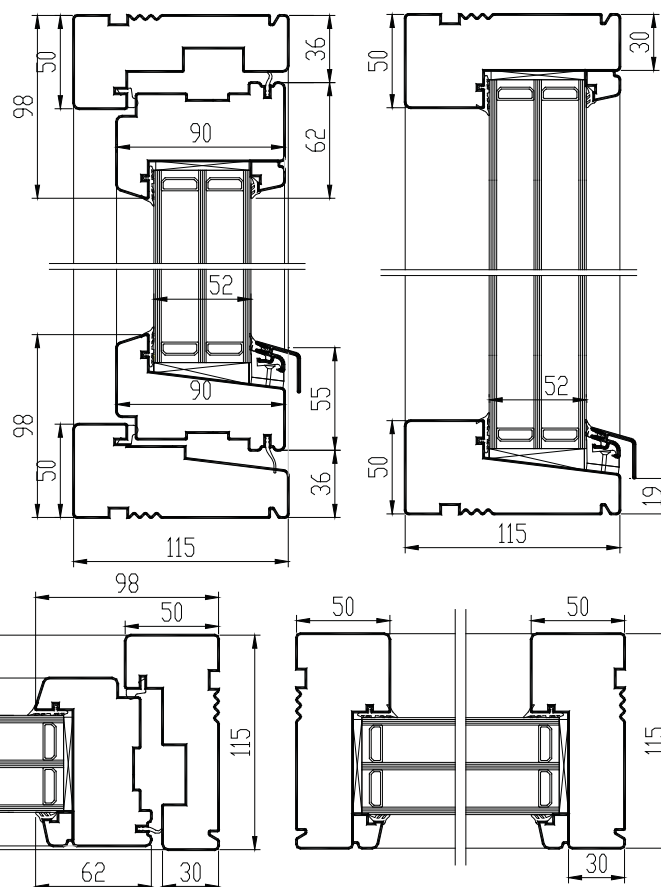

### GLAZING BAR OPTIONS

1. Glued on both sides+slats inside the glazing (Norwegian style)
2. Glued on both sides (Georgian style)

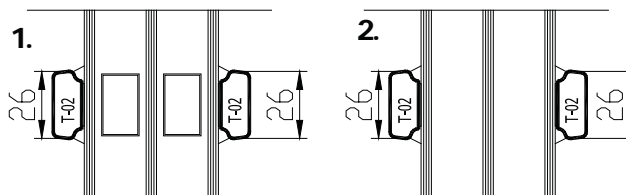

### OPENING:

Outside view

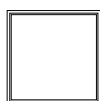

#### FIXED

*min dimensions 330x330 mm*

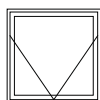

#### TOPGUIDED

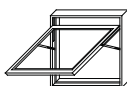

*dimensions L=400...1570; H=400...1580mm; max weight of sash 60 kg*

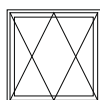

#### TOPSWING

The outer side of the window can be turned inside for easy cleaning.

*dimensions L=400...1670; H=600...1750mm; max weight of sash 60 kg*

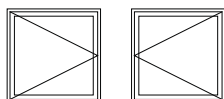

#### SIDEHUNG (LEFT / RIGHT)

*dimensions L=400...980; H=555...1680mm; max weight of sash 50 kg*

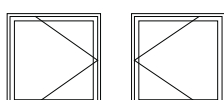

#### SIDE-SLIDEHUNG (LEFT / RIGHT)



*dimensions L=400...880; H=555...1680mm; max weight of sash 50 kg*